



Englert® sets the standard for innovative, efficient and environmental solutions.

Non Structural Metal Roofing Systems | Structural Metal Roofing Systems
Curved Panel Systems | Wall Panel Systems
Soffit Systems | Gutter Systems



Why Choose Englert?

- Since its founding in 1966, Englert has evolved into one of the pre-eminent forces in metal roofing and gutter systems. Englert offers architects and builders the most innovative and advanced solutions that uniquely combine aesthetics and performance. Englert is widely recognized as the leader in job site roll forming, where materials are custom cut and fit on-site, to provide a seamless, high quality product, with far less waste, and at lower costs than pre-formed panels.
- Englert technicians provide parts and service to any portable gutter or roof panel machine anywhere in the world. To meet special requirements, Englert does offer factory formed products through a comprehensive network of authorized independent manufacturers.
- To give the architect nearly limitless creative freedom in colors and finishes, Englert's own in-house continuous paint line offers the lowest minimum quantities in the industry. With our coating expertise and resources, as well as our on-staff specialists, you can expect your Englert roofing system to provide unsurpassed durability throughout the long life of the product. Our dried-in-place pretreatment system allows Englert to provide the most environmentally friendly coating process – eliminating harmful chromates. We can apply an array of coatings including: Energy Star® compliant Kynars®, silicone polyesters, polyesters, plastisols and acrylics. Even better, we can apply these coatings to aluminum, Galvalume®, galvanized, or cold rolled steel.
- Englert offers one of the widest ranges of metal roofing solutions in the industry, with all the roof profiles, finishes, textures, architectural details and structural options your design would require.

SELECTING ENGLERT METAL ROOF SYSTEMS

Aesthetics

- A wide range of seam profiles, panel widths and finishes to create the roof lines you desire.
- Narrow seams or wide batten-type profiles are available in both structural and non-structural systems.
- Optional ribs and striated patterns are also available to articulate the roof lines from ridge to eaves.
- The systems accommodate complex roof configurations, including hips, valleys, dormers and a broad range of pitches.
- Transitions between roof surfaces and other building elements, such as mansards, fascia, siding and soffits, can be cleanly and seamlessly detailed in a variety of profiles.
- Panel systems come in custom widths from 12" to 21".
- Flush seam panels can achieve flat surfaces on fascia walls and soffits.

Finishes

- Our exceptionally broad range of finishes, both custom and standard, can create anything from a natural weathered appearance to bright high-performance, full-strength fluorocarbon colors.

Structural Requirements

- Our 1000 series architectural roof systems are economical, non-structural profiles for application over decking in new construction or over existing roofs in retrofit applications.
- Englert's 2000 series roof systems meet UL and ASTM standards for structural roofing when applied directly over purlins or trusses.

Snap-Lock Versus Mechanical Seams

- Snap-lock systems offer easy, fast installation and uniform, clean-standing seam profiles, especially in transitions between roof surfaces to mansards and fascia. The locking panel profile continuously interlocks with the adjacent panel without mechanical seaming or additional caps. Panels are typically fastened to the substrate with concealed clips that provide clearance for thermal expansion and contraction. These systems have limited structural ratings and require a minimum slope of 3"/12".
- Mechanically-seamed systems are joined with a machine that folds each panel over the adjacent one to form a continuous, watertight seam. These systems are ideal for very low slopes, with pitches as shallow as 1/2"/12", and provide better air and water infiltration protection.

Product Selector

Englert System	Structural	Architectural detail capability	Tight radius curving capacity	Shallow slope (less than 3"/12")	Narrow seam	Wide seam	Flush seam	Snap-lock seam	Mechanical seam	Good transition between roof and mansard or fascia	UL-90 tested	Florida Building Code Compliant	ASTM water & air infiltration tested	Dade County tested	ASTM E-1592 tested	Weather-tightness warranties	FM Tested
A1000		●			●			●	●	●	●						
A1100		●				●		●		●	●	●					
A1101		●				●		●		●	●	●	●				
A1300 (1 1/2")		●		●	●				●	●	●	●	●	●	●	●	●
C1300 (1 1/2")		●	●	●	●				●	●	●	●	●	●	●	●	●
A1301(1")		●			●				●	●						●	
C1301(1")		●	●		●				●	●						●	
A1500		●			●			●		●	●	●				●	
S2000	●	●			●			●		●	●	●	●	●	●	●	●
S2400	●	●		●	●				●		●	●	●	●	●	●	●
C2400	●	●	●	●	●				●		●	●	●	●	●	●	●
S2500	●	●		●	●				●		●	●	●	●	●	●	●
S3000	●	●		●		●			●		●	●	●	●	●	●	●

*Contact Englert for specific materials tested, test parameters and limitations of each product before specifying from this chart.



NON STRUCTURAL Metal Roofing Systems

ENGLERT'S 1000 SERIES SYSTEMS are designed for steep sloped roofs and other exterior surfaces in light commercial and residential projects. Conventional architectural details can be used to provide a smooth transition from roof surfaces to mansards, fascia, walls and soffits. These systems offer economical solutions for installing metal roofing over plywood or metal decking in new construction and over existing shingle roofs in retrofit construction.

A1000-1 1/2" Snap-lock Panel

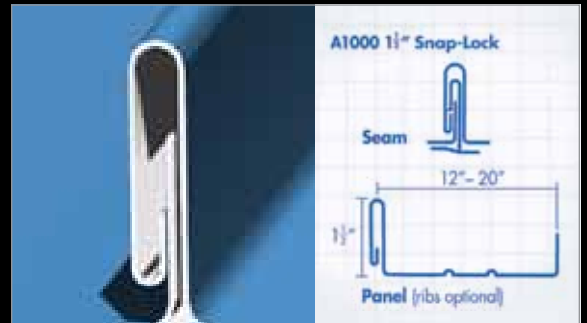

THE ENGLERT A1000 SERIES is a cost effective architectural system with concealed clips and fasteners, requiring no mechanical seaming or separate seam caps. The narrow standing seam can be notched and bent to provide a smooth transition from roof to fascia or mansard. Knee caps are applied over the notched seams to create visual continuity.

A1100—1 1/4" Integral Snap-Lock Panel

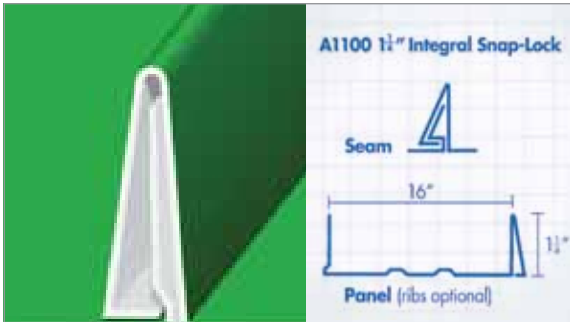

With only a 1 1/4" standing seam, ENGLERT A1100 SNAP-LOCK PANELS offer the designer an architectural system for creating clean roof lines with a minimum of shadows and textures.



A1101—1" Integral Snap-Lock Panel

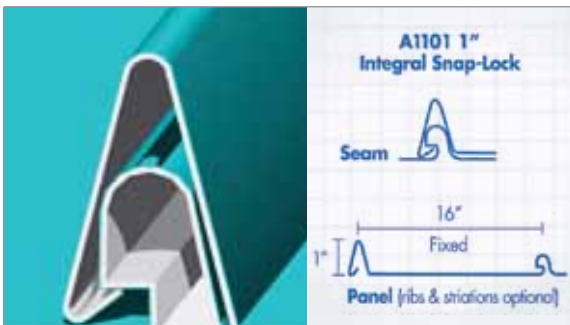

THE ENGLERT A1101 SERIES panel system combines the clean lines of a low profile architectural system with the unique versatility of a clipless hidden fastener design. Ideal for light duty commercial, residential and mansard/canopy applications on a solid deck.





A1300-1 1/2" Mechanically Seamed Panel

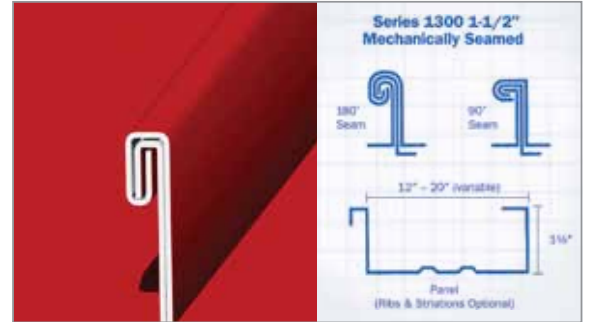

THE ENGLERT A1300 SERIES offers the same architectural detailing capability as architectural snap-lock panels. Transitions from roof surfaces to mansards, fascia, walls and soffits with the strength and weather tightness advantage of a mechanically seamed system.



A1301-1" Mechanically Seamed Panel



THE ENGLERT A1301 SERIES also offers the same architectural detailing capability as architectural snap-lock panels. Transitions from roof surfaces to mansards, fascia, walls and soffits with the strength and weather tightness advantage of a mechanically seamed system.

A1500-1 1/2" Integral Snap-Lock Panel

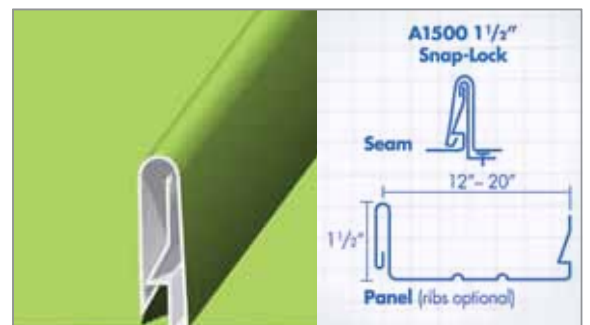

THE ENGLERT A1500 SERIES panel system combines the clean lines of a low profile architectural system with the unique versatility of a hidden fastener design. Ideal for light duty commercial, residential and mansard/canopy applications on a solid deck.



STRUCTURAL Metal Roofing Systems

ENGLERT OFFERS A FULL RANGE OF STRUCTURAL PANEL SYSTEMS with profiles that are designed for architectural-quality details at eaves and other edge conditions. These systems are specifically designed for spanning roof purlins and rafters at various spacings, many with very low minimum slope requirements.

S2000-1 3/4" Integral Snap-Lock Panel

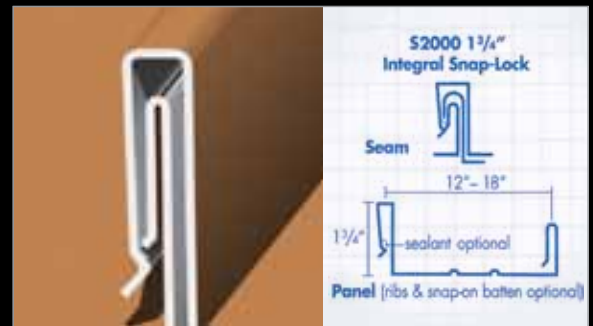

Englert's most popular system, this INTEGRAL SNAP-LOCK PANEL SYSTEM combines architectural versatility - for cleanly detailed, continuous seam transitions from roof to mansard, fascia, wall panel or soffit - with the dramatically increased spanning and uplift capabilities of a structural system.



S2400-2" Mechanically Seamed Panel

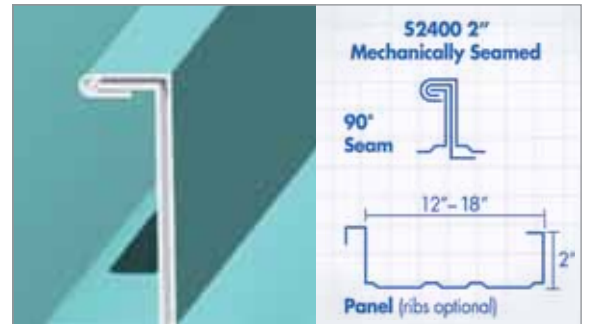

The S2400 is a structural panel with a thin, 2" standing seam. This mechanically seamed system is available in both single lock and double lock details. It is similar in appearance to the S2500 but lacks a down-leg on the male side so it can be curved.



S2500-2" Mechanically Seamed Panel

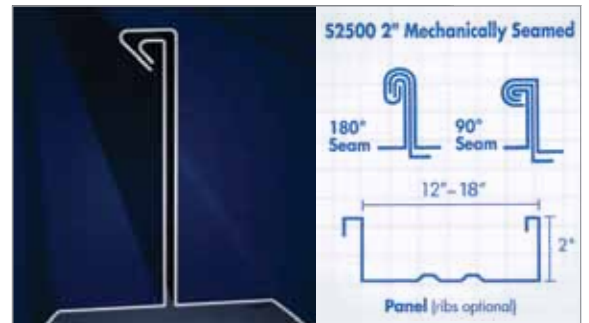

Designed particularly as a structural roof system for pre-engineered buildings, this "Armco style" panel is the industry's most extensively tested system, with over 50 years of history in the field. **THE S2500 PROFILE** incorporates a unique heavy-duty interlock clip that secures the system while allowing thermal expansion and contraction.



STRUCTURAL Metal Roofing Systems

Our structural panels use a hidden fastener system and are MECHANICALLY SEAMED TOGETHER MAKING THEM WEATHER-TIGHT. All of these systems can be installed over open framing or over a solid deck. Our structural systems are available in several steel and aluminum gauges and in a wide variety of ULTRA-Cool standard Kynar® colors.

THE SERIES 3000 Nominal 3" high mechanically seamed panel system is designed specifically for heavy industrial and large commercial buildings with low slope, long panel runs and wide span structural requirements.

In addition to its durability and ruggedness, this profile has been designed so that panels damaged by storms, falling objects and man-made causes can be individually removed without uprooting all panels of the damaged roof. The Series 3000 panels can also be installed bidirectionally.

S3000-3" T-Seam Mechanically Seamed Panel

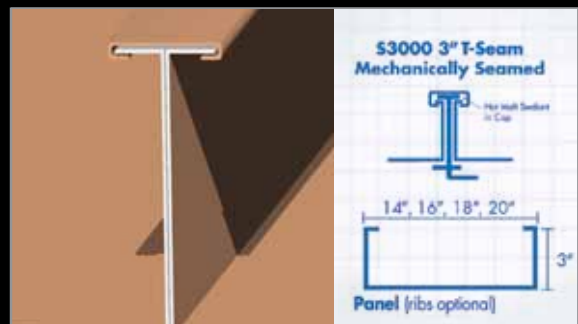

ENGLERT'S SERIES 3000 T-SEAM is a nominal 3" deep structural roofing system designed to provide excellent structural spanning capabilities as well as insuring a high, weather tight seam, even in the lowest, longest roof runs found in today's building designs.



CURVED PANELS

Englert offers mechanically seamed curved panel systems to accommodate a variety of architectural requirements. Designed for arched canopies and walk way covers, Englert's curved versions of the popular A1300, A1301 and S2400 profiles meet the needs of today's architects. Depending on the panels selected, these curved systems can be installed over solid decking or open steel. In addition, weather tightness warranties are available for these curved systems.



Material	A1301 1" Seam	Minimum Radius		Convex Curve	Tapered Curve	Elliptical Curve
		A1300 1 1/2" Seam	S2400 2" Seam			
Aluminum (up to .040")	24"	24"	118"	Yes	Yes	Yes
Copper (up to 20 oz.)	24"	30"	118"	Yes	Yes	Yes
Steel (up to 24 ga.)	60"	100"	118"	Yes	Yes	Yes
Stainless Steel (up to 26 ga.)	120"	160"	118"	Yes	Yes	Yes



WALL PANELS

Englert is distinctive for its ability to provide you with a broad range of wall panel systems for a wide variety of design purposes. Choose from one or more of our commercial-industrial wall panel systems to enrich the look and function of any project you design. Select from a full line of Englert wall panel systems to give your building a unique look and feel.

Product* Testings and Co-Listing					
Commercial/ Industrial	ASTM 283	ASTM 330	ASTM 331	ASTM 84	Paint Performance Specs
Uniline R	●	●	●	●	●
Uniline RW	●	●	●	●	●
Uniline C-36	●	●	●	●	●
Uniline 4.2	●	●	●	●	●
2.67" x .5"	●	●	●	●	●
2.67" x .875"	●	●	●	●	●
A-4000	●	●	●	●	●
B-4000	●	●	●	●	●
B-4000 R	●	●	●	●	●
H-12/3	●	●	●	●	●
H-16/4	●	●	●	●	●

*Contact Englert for specific materials tested, test parameters and limitations of each product before specifying from this chart.



COMMERCIAL/INDUSTRIAL WALL PANEL SYSTEMS

Englert offers a wide range of traditional concealed and thru-fastened wall panel systems that can be installed horizontally or vertically for all kinds of commercial and industrial use. Our commercial-industrial systems are available in a wide range of colors all in a Kynar 500® paint finish that meet specific aesthetic and corrosion resistance requirements. Architects and builders can choose from a variety of Englert's economical and durable wall panel systems, suitable for use in pre-engineered metal building applications, agricultural structures, commercial buildings, and industrial buildings.



COMMERCIAL/INDUSTRIAL WALL PANEL SYSTEMS: CONCEALED FASTENER

The Englert H-12 and H-16 series wall panel systems provide architects and designers with the definitive solution to design versatility. These multi-purpose metal wall panels feature a concealed fastener system with a fastening leg, and lock, that is hidden. Panels are coated with an ULTRA-Cool™, Kynar 500® paint finish.

CF Series



The Series A4000 flush interlocking wall panel system provides consistently smooth wall surfaces. Unobtrusive vertical seams with concealed integral fasteners are secured without the need for additional clips or mechanical seaming. Optional stiffeners are recommended for lighter gauge material. The panels also may be detailed in combination with insulation to produce an insulated siding system.

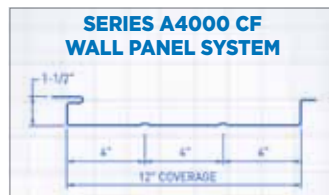

Horizontal Series

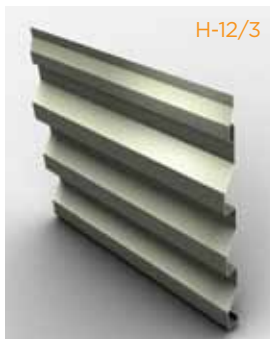

The Englert H-12/3 is a 12" coverage panel, 7/8" deep with three ribs uniformly spaced ideal for architectural, commercial and industrial applications demanding a bolder surface appearance.

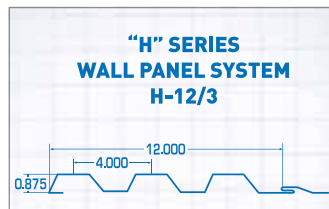

The Englert H-16/4 is a 16" coverage panel, 7/8" deep with four ribs uniformly spaced to create a bolder surface appearance for architectural, commercial and industrial applications.

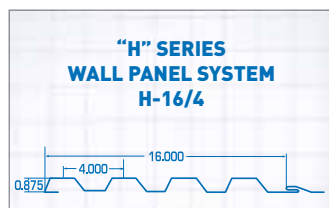



Corrugated Series



2.67" x .5"

The 2.67" x .5" corrugated wall panel system is ideal for standard applications requiring both durability and economy.



2.67" x .875"

The Englert 2.67" x .875" corrugated wall panel system is specifically designed for use in industrial applications. With a deeper corrugation, this panel provides increased load carrying capacity and adds heavier shadow lines.

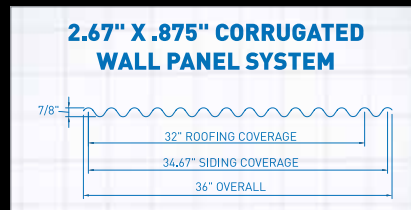
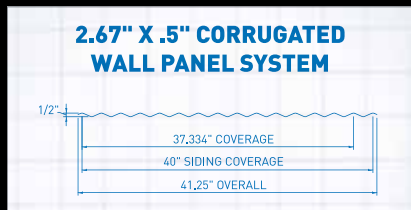

COMMERCIAL/INDUSTRIAL WALL PANEL SYSTEMS: EXPOSED FASTENER

Uniline Series



The Uniline 4.2 Rib wall panel is a traditional 1 1/16" deep 4.2 symmetrical ribbed wall panel. Typically used in an industrial application, these wall panel systems are ideal for use in retrofit applications on older buildings.

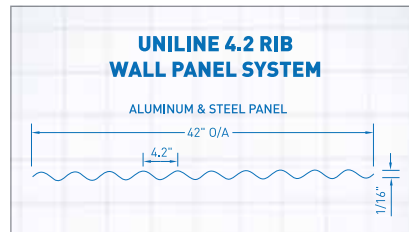

The Uniline C-36 wall panel is 1.5" deep with symmetrically spaced ribs at 7.2" on center making it ideal for use in a variety of applications. Uniline C-36 wall panels have a trapezoidal profile and can be installed either vertically or horizontally for a more dramatic effect, particularly in architectural applications.

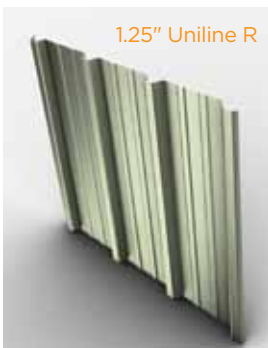
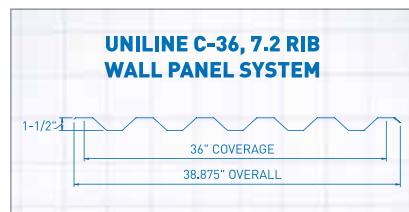

The Uniline "R" wall panel system, the staple of the metal building industry, combines strength with a deep, wide panel profile for a clean, bold look. The wall panel is easy to install and is designed for maximum durability. Available in all Englert standard Kynar® colors.

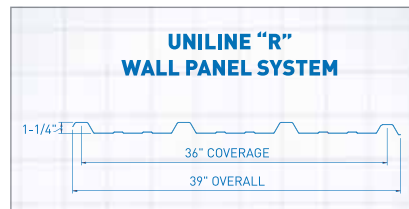

The Uniline "RW" wall panel is a semi-concealed fastener wall panel that combines form and function. With its recessed channels housing its fasteners, the "RW" creates a smooth, flat wall appearance. This durable wall panel system is a good choice for standard wall applications where architectural detail is important. The "RW" wall panel provides a striking wainscoted architectural effect.

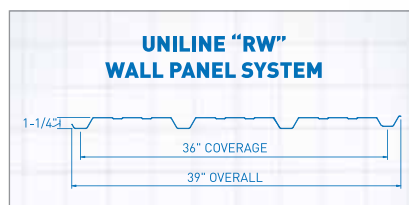



SOFFIT PANELS

Englert offers concealed fastener soffit wall panel systems. These products are available in a wide range of colors and gauges, and are factory formed and shipped worldwide in lengths that are available to suit your design needs. Contact Englert for comprehensive load tables and design assistance with any of these profiles.

B4000-1" Flush Soffit Panel

Englert's B4000 flush interlocking panel system with a smooth soffit surface is ideal for applications where a flush or flat appearance is desired. A concealed fastening system improves the flush appearance while providing additional strength. Optional stiffeners are available to ensure flat, level planes.

B4000 R Flush Soffit Panel

B4000 R flush interlocking panel system with a one-inch reveal is for applications where a shadow appearance is desired. The B4000 R has a concealed fastening system that improves the flush appearance while providing additional strength. Optional stiffeners are available to ensure flat, level planes.

E375—3/8" Soffit Panel

Englert E375 Commercial/Residential Soffit Panel in solid or vented styles features 3/8" Deep V Groove, unobtrusive seams with positive lock and concealed fasteners and net free ventilation area (NFVA) of 10.12 square inches per square foot.

B4000-1" Flush Soffit Panel



B4000-R Flush Soffit Panel

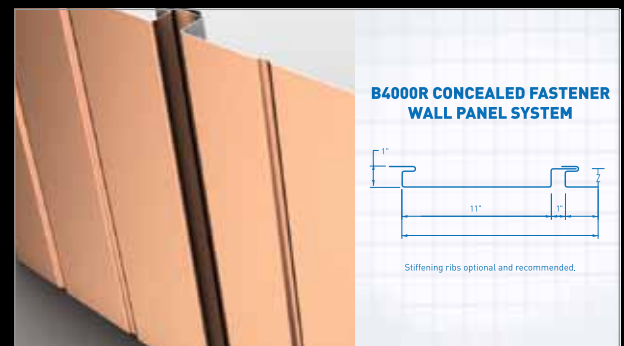

E375-3/8" Soffit Panel

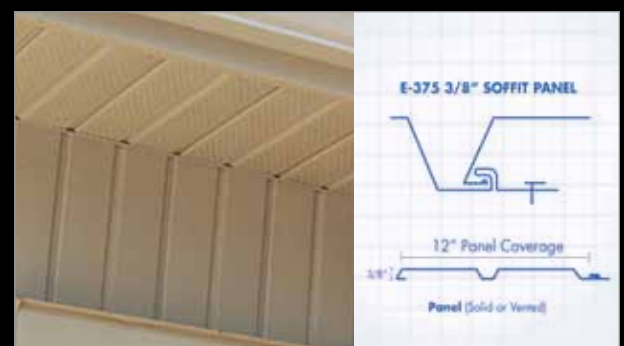



RainPro

GUTTER SYSTEMS



LeafGuard

LeafGuard

LeafGuard is a rain gutter protection system with a one-piece, patented, debris shedding design that is better than any other gutter on the market today. It features a hood built into the gutter itself - not added on to it, or attached above it - making LeafGuard functionally and aesthetically better than gutter covers, gutter screens, gutter hoods, or gutter helmets. LeafGuard is designed to enhance the beauty of any home design.



RainPro (Pictured with MicroGuard)

RainPro

The RainPro Design Series gutter system is the only gutter on the market today with the capacity of a 6" gutter, and a unique design with a touch of elegance that complements the distinctive lines, flourishes and shapes of exterior moldings and other exterior ornamentation that people choose for their homes and commercial buildings. RainPro's wider gutter bottom and larger 3 3/8" outlet gives your home design a dramatic increase in water flow capacity compared to a 5" gutter system which only has a 2 3/8" outlet.



7" Box Gutter

7" Box Gutter

The Englert 7" Box Gutter profile is designed for use in commercial and light industrial applications where an attractive, yet functional, rain carrying system is required. The large 7" trough is capable of handling high volumes of water that are typically found draining from larger commercial roof installations.

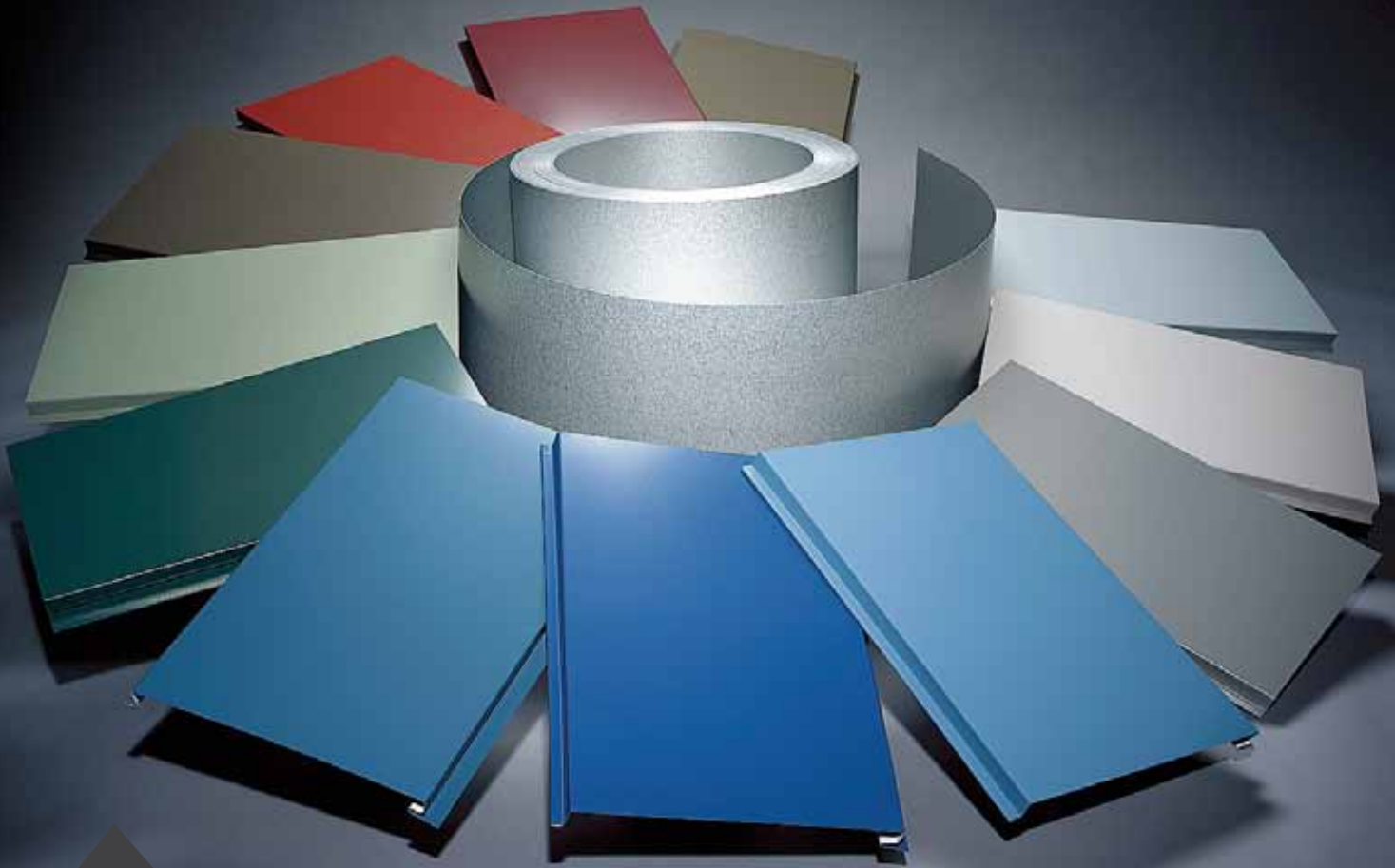

COATINGS AND TECHNOLOGY

Englert's in-house continuous coil coating line processes product in five basic steps. The base metal is cleaned in an alkaline bath, rinsed with hot water, and chemically pretreated using a dried-in-place pretreatment. Next, a primer is applied, and then baked on, followed by an oven cured top coat.

Typical substrates coated are aluminum, hot dipped galvanized steel, Galvalume®, and cold rolled steel. Coatings that can be applied are acrylics, polyesters, plastisol, siliconized polyesters, full strength 70% Kynar 500®/Hylar 5000® fluorocarbons. Finishes can be applied to either the top side or both sides of the substrate.

Englert's coil coating line is equipped with quick change heads, so color changes can be accomplished without line shutdown, facilitating the coating of a wide range of finishes in minimum quantities.

Englert's in-house paint line also has the ability to apply a thick film Kynar based paint system that is capable of withstanding 100 liters plus of falling sand as required in many government specifications.

Englert and LEED®: PERFECT TOGETHER

Englert metal roofing products contribute significantly to the sustainable building movement. As an active member of the U.S. Green Building Council, we were one of the first roofing manufacturers in the world to offer our customers an ULTRA-Cool™ roofing product. We have worked closely with renewable energy companies to manufacture metal roofing products that can conserve and recycle energy and water for a better environment.

An Englert metal roof presents architects and builders with the capability to collect more than a dozen credits in designing a LEED® accredited project. Our coatings have both the high reflectance and high emittance necessary to meet LEED® requirements for cool roofing. An Englert steel or aluminum standing seam roof qualifies for LEED® credit requirements for recycled content and recyclability. Our metal roofs are excellent for the recovery and reuse of non-potable water, an important factor in earning LEED® water efficiency credits. An Englert metal roof provides both the critical platform and the shelter for the new rooftop solar photovoltaic and thermal technologies that earn LEED® credits for energy efficiency.

Best of all, an Englert metal roof provides strength and versatility, is maintenance free and comes in dozens of standard and custom ULTRA-Cool™ colors to fit your personal preference.



COATINGS AND TECHNOLOGY

Custom Colors: Englert offers a wide range of custom colors with short lead times and low minimum order requirements depending on the type of substrate. Englert can match the color of virtually any material, including brick, wood and fabric.

PermaColor 3500/PermaMetallics 3500: These low gloss ULTRA-Cool™ Kynar coatings are comprised of 70% Full Strength Kynar 500®/Hylar 5000® fluorocarbon (Polyvinylidene fluoride PVDF) coating over a urethane primer. Both carry a 35 year paint finish warranty. (The reverse side consists of a primer and a wash coat.)

Galvalume-Plus: Englert offers the cutting edge in metal roof technology – a premium steel product known as Galvalume-Plus®. This product has the advantage of an acrylic coating to reduce mill finish discoloration and uneven weathering.

ULTRA-Cool™ is state-of-the-art when it comes to energy-efficient metal roofing. Using PPG's ULTRA-Cool™ coatings, ULTRA-Cool™ colors meet Energy Star's® specs for Initial Solar Reflectance for Cool Roofs and not only saves energy but money as well because:

- Heat is reflected away from the building
- Smog is reduced when environmental temperatures are reduced
- Energy costs are saved because of cooler interior spaces
- Life expectancy of the roof is increased due to less expansion and contraction
- Monetary incentives are increasingly being offered for switching to reflective roofing products
- They meet the LEED® 2.2 Solar Reflective Index

Striating: Striating is a process of adding light vertical lines to the broad face of the metal roof panels at the last stage of roll forming. This process induces a shadow form effect. Combined with our low gloss Kynar coating it helps reduce oil canning, giving the system a smooth, linear appearance.

Oil-Canning: The roll forming process can sometimes result in inherent surface unevenness. This is referred to as "oil-canning." This condition is also caused by thermal expansion and contraction, dark colors, high gloss finishes and uneven substrate. "Oil-canning" in and of itself is not sufficient cause for material rejection.

Kynar 500® is a registered trademark of Atofina Chemicals Inc.
Hylar 5000® is a registered trademark of Ausimont USA Inc.

Galvalume® and Galvalume Plus® are registered trademarks of BIEC Industries Inc.
ULTRA-Cool™ is a trademark of the PPG Corp.

PermaColor 3500—Full Strength 70% Kynar 500®/Hylar 5000®

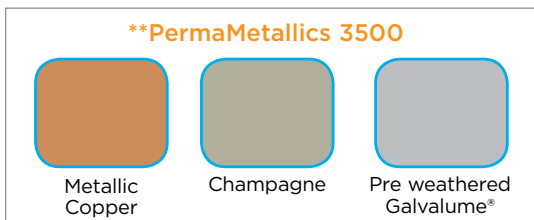

Contact Englert directly at 1-800-364-5378 for current LEED™ compliant information. Due to the limitations of printing processes, this color chart is not an accurate representation of our actual colors. Sample chips are available on request at no charge. All Englert colors are Energy Star® compliant.

**These are premium priced paint systems that carry a 35 year paint finish warranty.





FOR THE ARCHITECT

At Englert, we understand that the responsibility for delivering the best metal roofing and wall panel solutions for your client's new building or renovation is ours. Beyond our extensive line of architectural and structural roofing products and services, we also offer you the essential information you need for the optimal building envelope design.

Based upon an understanding of the building requirements, we work with you and your contractor to properly prepare specifications that meet your client's needs and budget. Englert is your roofing and wall panel resource, providing cutting edge information to architects and specifiers throughout the United States.

Our fully trained staff of architectural representatives and engineers is available to make sure your projects run smoothly. We provide design professionals like you with services that make your life easier, from education to spec development. With a variety of AIA registered programs

to choose from (Go to www.englertinc.com for more information), we offer architects the hands-on expertise and information they need about metal materials and components to optimize a project and minimize architectural liabilities. Our architectural representatives are available to present these seminars at your office or in your local area upon request.

We are a member of the U.S. Green Building Council. We offer a full line of LEED® and Energy Star® compliant building envelope systems complete with the company's own integrated rooftop solar photovoltaic, solar thermal and rainwater harvesting products. And our technical and advisory staffs have authored numerous articles on metal roofing's contribution to the sustainable building movement including its energy efficiency, high recycled content, total recyclability, water efficiency and energy and atmosphere LEED® credit programs.



M E M B E R



N A T I O N A L
C O I L C O A T E R S
A S S O C I A T I O N



1200 Amboy Avenue, Perth Amboy, NJ 08861
Phone: (732) 826-8614 • Fax: (732) 826-8865 www.englertinc.com

