

PHASE 1: INSTALL PRODUCTS

FOR USE ON SOLID SUBSTRATES SUCH AS:
SOLID DECK, HARD SURFACE, or OPEN FRAMING

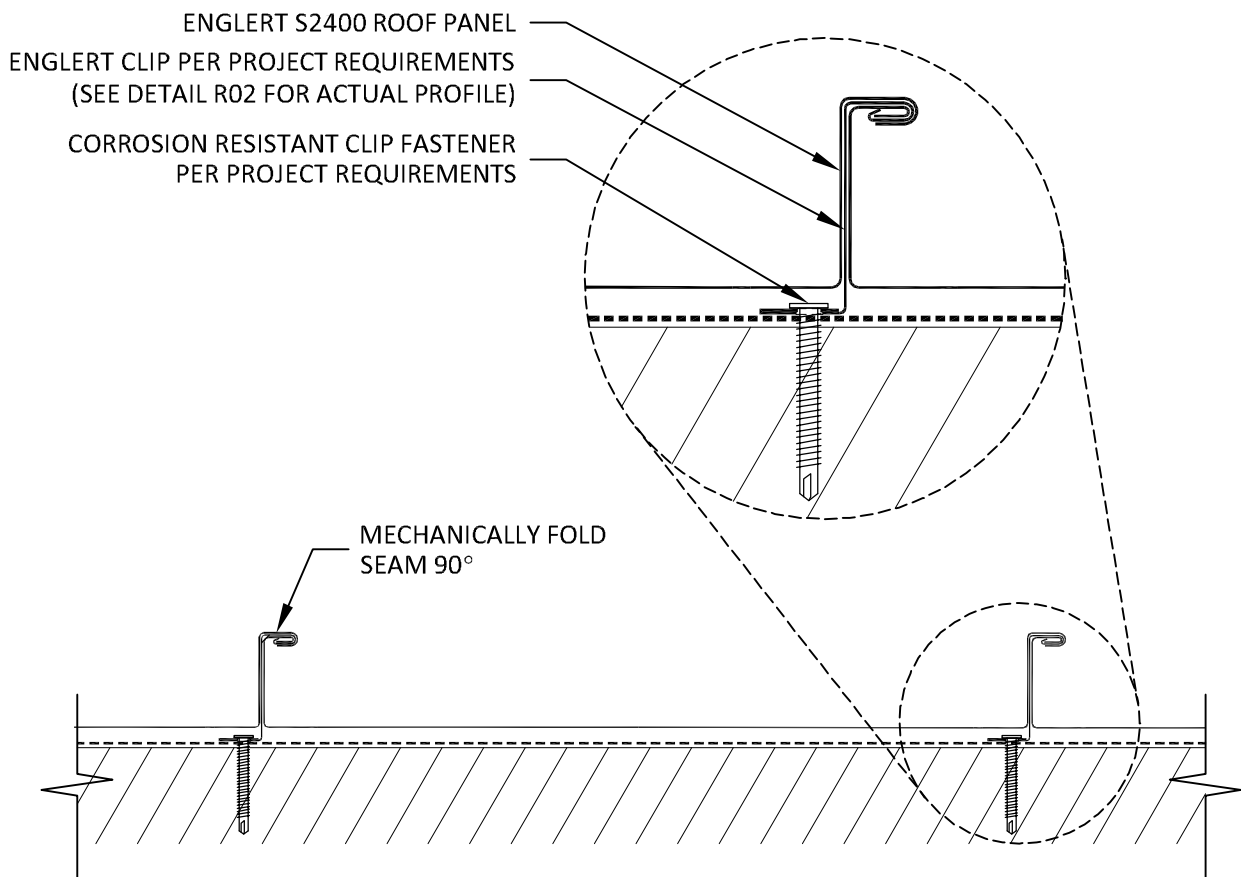

PHASE 2: FIELD SEAMING

ENGLERT
www.englertinc.com
800-364-5378

GENERIC BEST PRACTICE ASSEMBLY SHOWN. WATERTIGHTNESS WARRANTY NOT IMPLIED. WHEN SITE CONDITION DIFFERS, SPECIFIC ENGINEERING NECESSARY.

ROOF PANEL SEAM	
SERIES S2400 - 90° SEAM	

DETAIL SUBJECT TO CHANGE WITHOUT NOTICE.
Detail #
R04.24-s