

CURB w/ TRIM

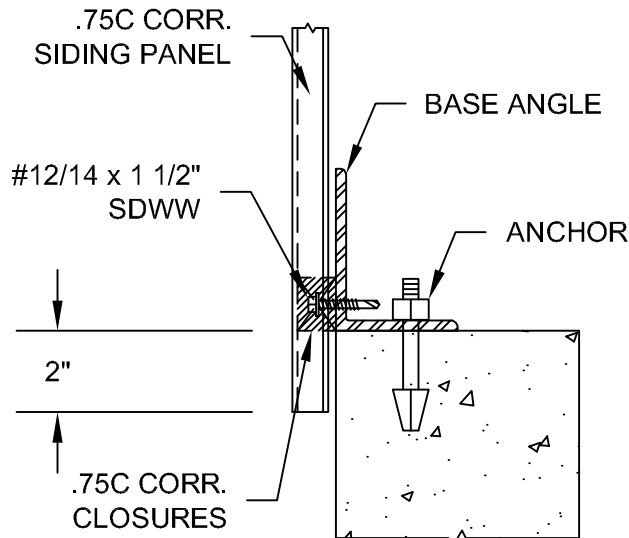

CURB w/ CLOSURE

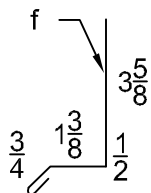

"BD3" BASE TRIM

ENGLERT
www.englertinc.com
800-364-5378

2.67" x .75 CORRUGATED STANDARD DETAILS

DETAIL SUBJECT TO CHANGE
WITHOUT NOTICE.

BASE DETAILS

Detail #

W.75.09

GENERIC BEST PRACTICE ASSEMBLY
SHOWN. WATERTIGHTNESS
WARRANTY NOT IMPLIED.
WHEN SITE CONDITION DIFFERS,
SPECIFIC ENGINEERING NECESSARY.

Project:
Date:

Scale: NTS

Location:

By: